

m o o o i[®]



Something Like This Sofa

by Maarten Baas

The Something Like This Sofa is a celebration of the designer's love for sketchy drawings translated into a soft, unusually modelled sofa.

CONFIGURE

Designer

Maarten Baas

Year of design

2018

m o o o i[®]

Dimensions chaise longue left

133cm | 52.4"

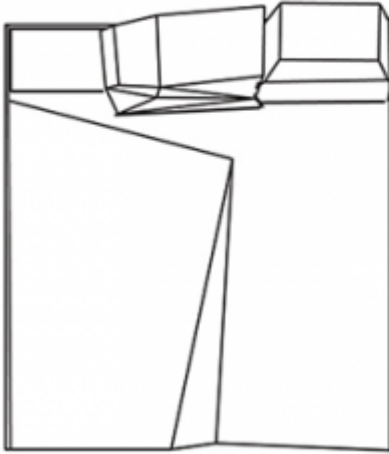

154cm | 60.6"

41cm | 16.1"

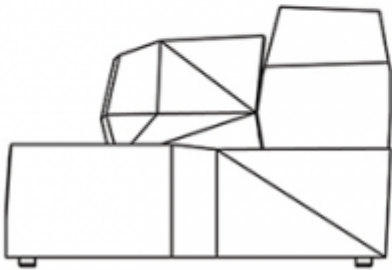

39cm | 15.4"

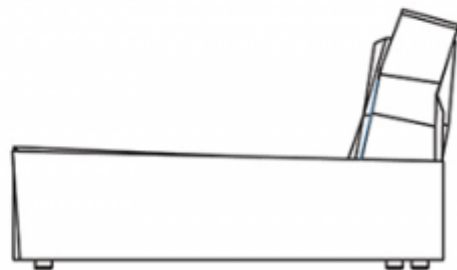

88cm | 34.6"

m o o o i[®]

Dimensions chaise longue right

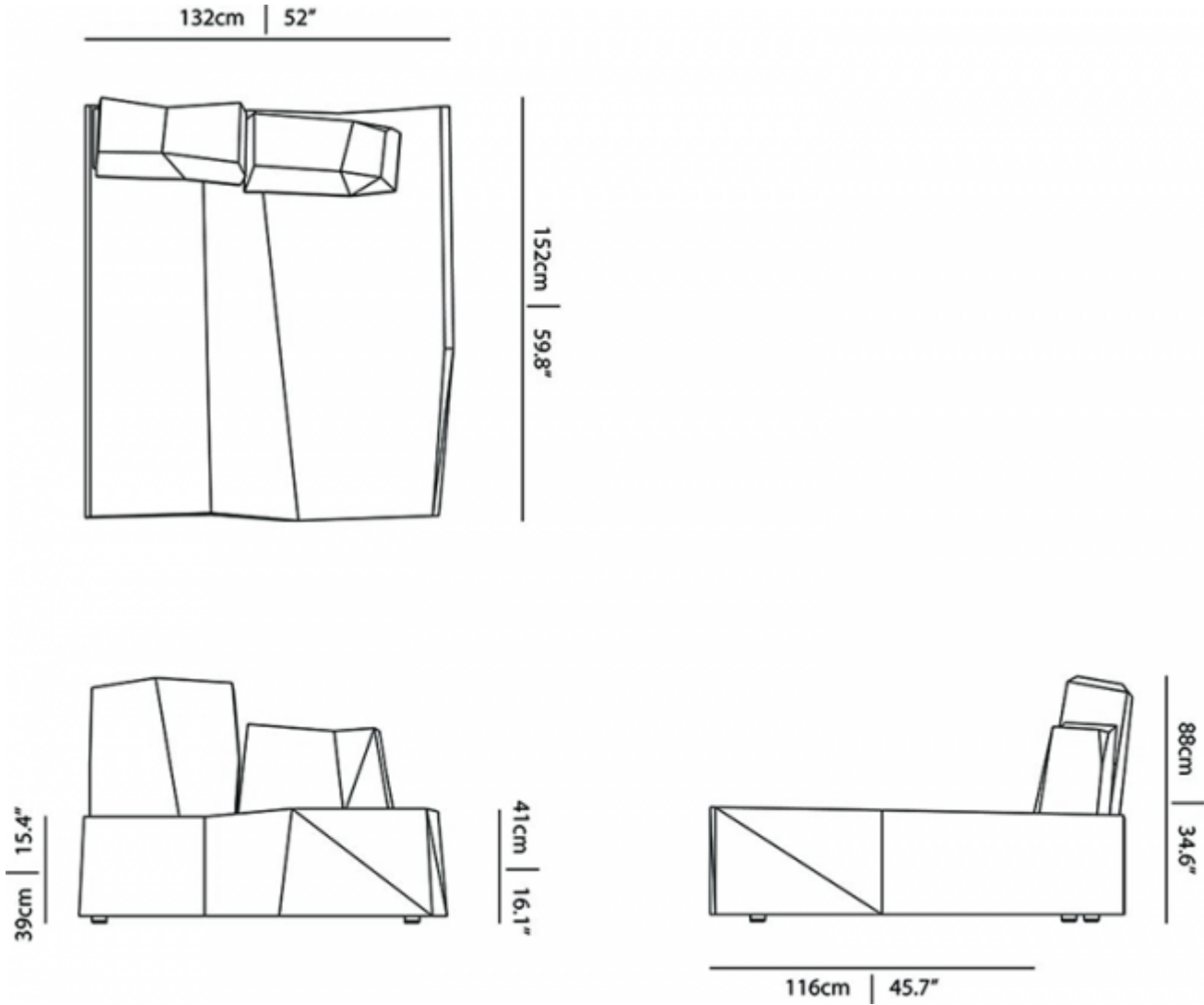

m o o o i[®]

Dimensions double seat

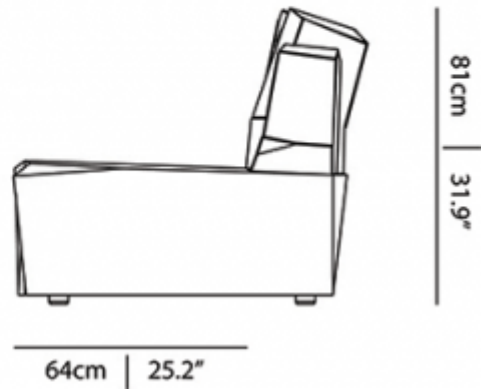
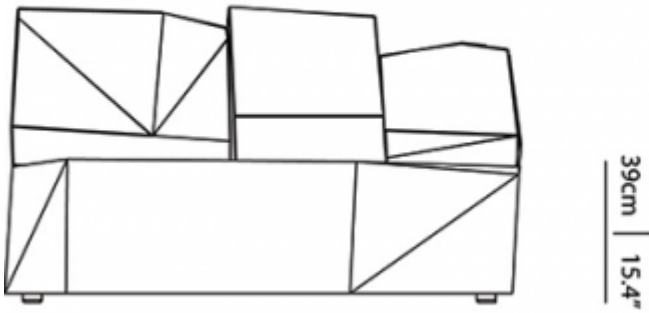
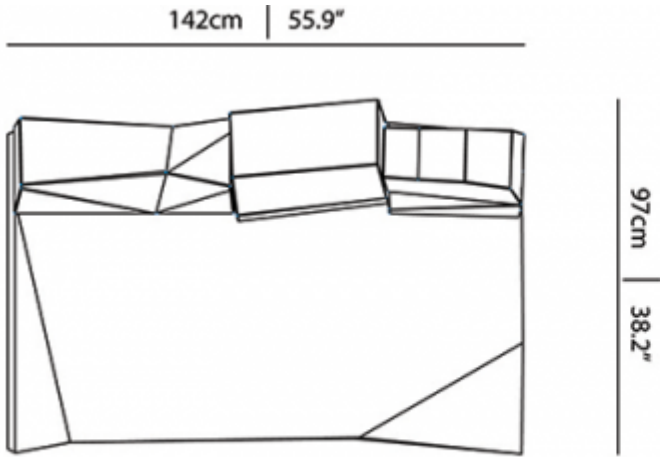

m o o o i[®]

Abbracci

composition

100% pl

abrasion

50.000 martindale

lightfastness 4

firetest

FR BS5852 0/1

EN1021 I&2



Abbracci
Black



Abbracci
Brown



Abbracci
Grey

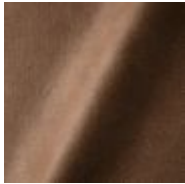

Abbracci
Taupe

m o o o i[®]

Solis

composition

2% PA 3% PC 30% PL 65% WO

abrasion

40.000 Martindale rubs, EN ISO 12947

lightfastness

Note 5, EN ISO 105-B02

firetest

EN 1021-1/2

US. Cal. Bull. 117-2013

Upon request, with treatment:

BS5852 part 1

BS5852 crib 5



Solis
Crust



Solis
Dawn



Solis
Fog



Solis
Paper



Solis
Rain



Solis
Spencer



Solis
Sunset

m o o o i[®]

Justo

composition

15% CO, 35% PC, 10% PL, 40% VI

abrasion

50.000 Martindale rubs, EN ISO 12947

lightfastness

Note 5, EN ISO 105-B02

fire test

EN 1021-1/2

US. Cal. Bull. 117-2013

NFPA 260

Upon request, with treatment:

BS5852 part I

BS5852 crib5



Justo
Alge

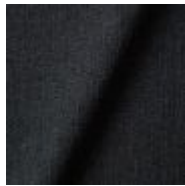

Justo
Bazalt



Justo
Bred



Justo
Hinde



Justo
Lyse



Justo
Muse



Justo
Sennep



Justo
Sten

m o o o i[®]

Liscio

composition

35% WO / 35% CV / 21% CO / 9% PA

abrasion

30.000 Martindale

lightfastness

4-6

firetest

US. Cal. Bull. 117-2013

Upon request, with treatment:

BS5852 part I



Liscio
Grigio Blu Scuro



Liscio
Grigio Blu



Liscio
Grigio Scuro



Liscio
Muscio



Liscio
Argento



Liscio
Nebbia



Liscio
Perla



Liscio
Latte Scuro



Liscio
Latte

Vesper

composition

10% CO, 40% L, 10% PA, 10% PL, 30% VI

abrasion

40.000 Martindale rubs, EN ISO 12947

lightfastness

Note 5, EN ISO 105-B02

firetest

EN 1021-1/2

US. Cal. Bull. 117-2013

Upon request, with treatment:

BS5852 part 1

BS5852 crib 5



Vesper
Aluminium



Vesper
Brass



Vesper
Bronze



Vesper
Nickel



Vesper
Silver

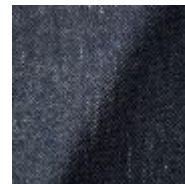

Vesper
Steel

m o o o i[®]

Twill

composition

72% wo, 8% pa, 20% pl

abrasion

75.000 martindale

lightfastness 5

firetest

EN1021 I&2



Twill
Caviar

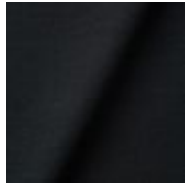

Twill
Graphite

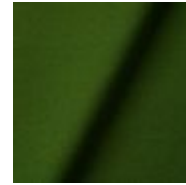

Twill
Grass



Twill
Linen

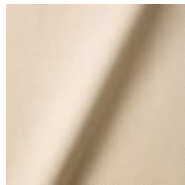

Twill
Natural

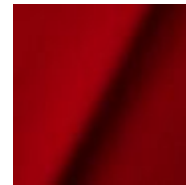

Twill
Passion

Twill Melange

composition

60% WO / 20% PES / 20% PA

abrasion

80.000 martindale

lightfastness 6-7

firetest

EN1021-1/2

US. Cal. Bull. 117-2013

BS5852 part I

DIN 4102-B2

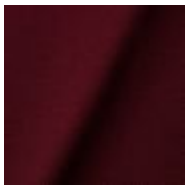

Twill Melange
Chili



Twill Melange
Dust

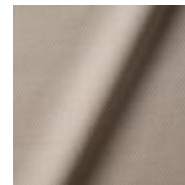

Twill Melange
Flour

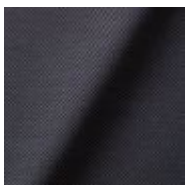

Twill Melange
Lavender

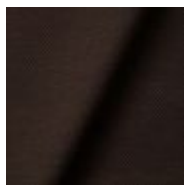

Twill Melange
Peat

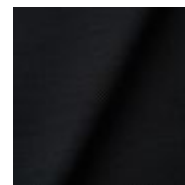

Twill Melange
Slate

m o o o i[®]

Plush

composition

85% PC / 15% PL

abrasion

NA

lightfastness NA

firetest

NA



white

Cervino Leather

composition

100% aniline leather

Leather is a natural product, colours may vary from hide to hide.

firetest

EN1021 I&2

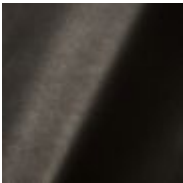

Cervino Leather
Anthracite



Cervino Leather
Cognac



Cervino Leather
Mud



Kvadrat Fabrics

Kvadrat Fabrics

Selected Moooi products can be upholstered with a collection of Kvadrat fabrics. Kvadrat designs high-quality upholstery, in an extensive range of colours and textures.

Go to our Kvadrat fabrics page for a full overview of all fabric families you can choose from.

Image not found or type unknown



Dodo Pavone Jacquard

composition

12% CO 88% PL

abrasion

40.000 Martindale rubs, EN ISO 12947

lightfastness

Note 5, EN ISO 105-B02

firetest

US. Cal. Bull. 117-2013

Upon request, with treatment:

BS5852 part I



**Extinct Animals
Fabric Collection**
Dodo Pavone Jacquard

m o o o i[®]

Blushing Sloth Melange Mohair

composition

29% LANA / 24% LANA WM / 24% PES / 15% PA / 8% CO

abrasion

40.000 Martindale rubs, EN ISO 12947

lightfastness

Note 4-6, EN ISO 105-B02



Extinct Animals

Fabric Collection

Blushing Sloth Melange
Mohair

Blushing Sloth Woolly Mohair

composition

85% WV / 15% WM

abrasion

15.000 Martindale rubs, EN ISO 12947

lightfastness

Note 4-6, EN ISO 105-B02

firetest

EN1021-1/2

BS5852 part I

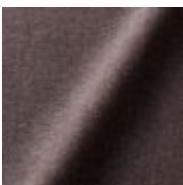

Extinct Animals

Fabric Collection

Blushing Sloth Woolly
Mohair

m o o o i[®]

Calligraphy Bird Jacquard

composition

64% VI, 21% PES, 15% CO

abrasion

50.000 Martindale rubs, EN ISO 12947

lightfastness

Note 4-6, EN ISO 105-B02

firetest

Upon request, with treatment;
BS5852 part I

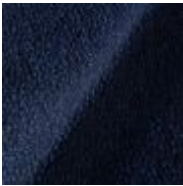

Extinct Animals Fabric
Collection
Calligraphy Bird
Jacquard

Dwarf Rhino Crackle

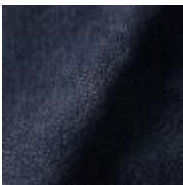

**Extinct Animals
Fabric Collection**
Dwarf Rhino Crackle

m o o o i[®]

Armoured Boar Crackle

composition

100% cow hide

Type of leather

Pure aniline, nubuck finish



**Extinct Animals
Fabric Collection**
Armoured Boar Crackle

Armoured Boar Hairy

composition

100% cow skin

lightfastness

>3, ISO 105-B02:2004



Extinct Animals Fabric Collection
Armoured Boar Hairy